

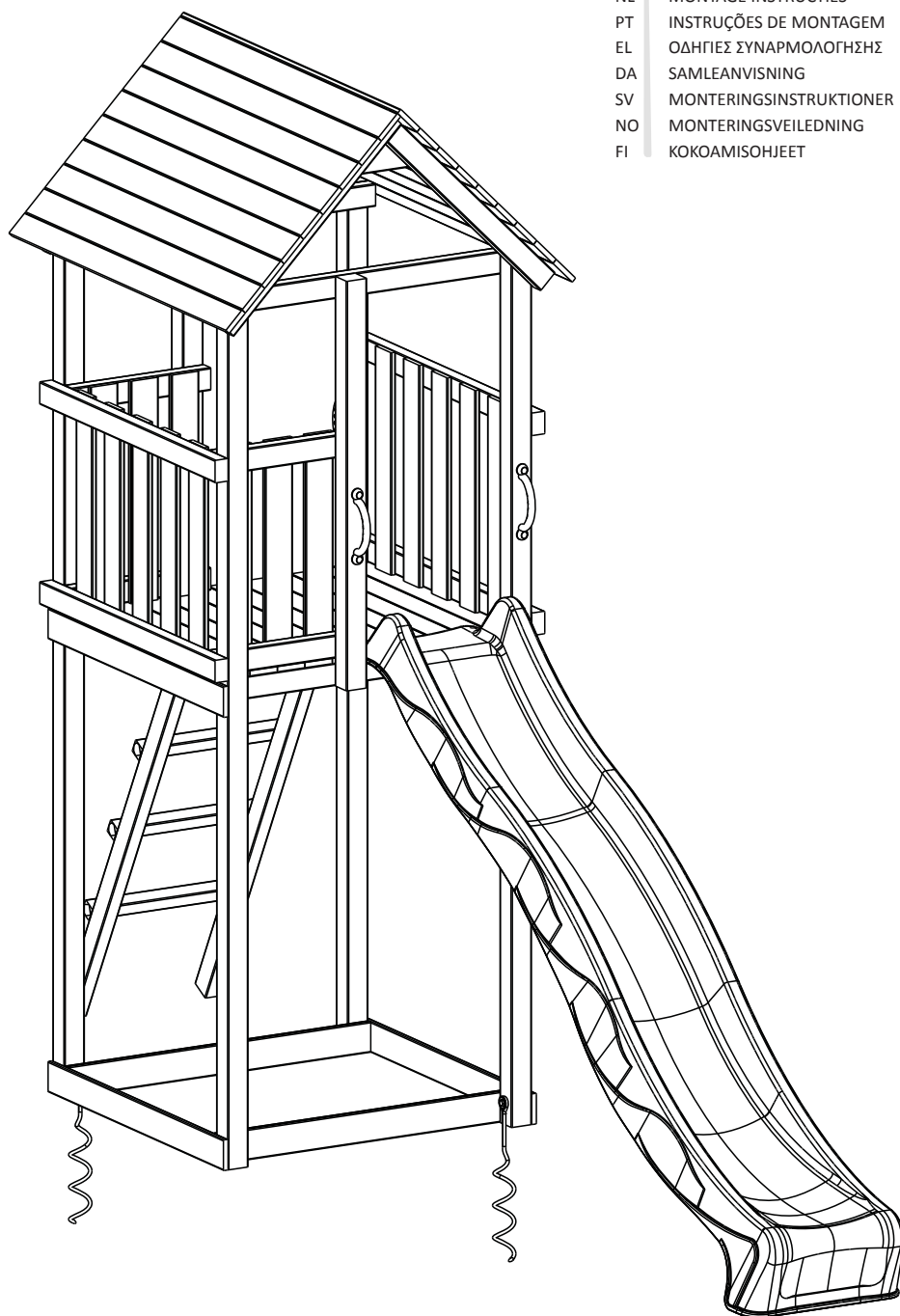

**blue rabbit**

# Kiosk

EN	ASSEMBLY INSTRUCTIONS	PL	INSTRUKCJA MONTAŻU
DE	MONTAGEANLEITUNGEN	CZ	NÁVOD K MONTÁŽI
FR	INSTRUCTIONS DE MONTAGE	SK	MONTÁŽNY NÁVOD
ES	INSTRUCCIONES DE MONTAJE	SI	NAVODILA ZA MONTAŽO
IT	ISTRUZIONI PER L'ASSEMBLAGGIO	HR	UPUTE ZA MONTAŽU
NL	MONTAGE INSTRUCTIES	HU	ÖSSZESZERELÉSI ÚTMUTATÓ
PT	INSTRUÇÕES DE MONTAGEM	RO	INSTRUCȚIUNI DE ASAMBLARE
EL	ΟΔΗΓΙΕΣ ΣΥΝΑΡΜΟΛΟΓΗΣΗΣ	BG	ИНСТРУКЦИЯ ЗА МОНТАЖ
DA	SAMLEANVISNING	LT	MONTAVIMO INSTRUKCIJA
SV	MONTERINGSINSTRUKTIONER	LV	MONTĀŽAS NORĀDĪJUMI
NO	MONTERINGSVEILEDNING	EE	KOKKUPANEMISUJUHEND
FI	KOKOAMISOHJEET	RU	ИНСТРУКЦИЯ ПО СБОРКЕ



**blue rabbit 2.0**















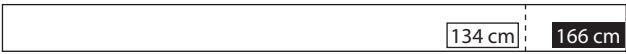





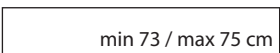

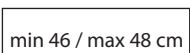

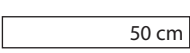
© 2014

Blue Rabbit 2.0 - Hemelrijken 8 - B-2890 St-Amands - Belgium.  
Copyrighted material - Do not reproduce under penalty of law.

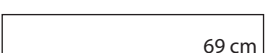

EN 71-1, 2, 3 & 8

IM008.001.001-v02 (2015-06)

- 4x** **A** min 68 mm max 90 mm   240 cm 270 cm  
min 68 mm max 90 mm
- 2x** **B** min 68 mm max 90 mm   127 cm  
min 68 mm max 90 mm
- 2x** **C** min 68 mm max 90 mm   134 cm 166 cm  
min 32 mm max 50 mm
- 9x** **D** min 68 mm max 90 mm   105 cm  
min 32 mm max 50 mm
- 2x** **E** min 68 mm max 90 mm   82 cm  
min 32 mm max 50 mm
- 2x** **F** min 68 mm max 90 mm   min 73 / max 75 cm  
min 32 mm max 50 mm
- 4x** **G** min 68 mm max 90 mm   min 46 / max 48 cm  
min 32 mm max 50 mm
- 3x 4x** **H** min 44 mm max 45 mm   50 cm  
min 44 mm max 45 mm
- 12x\*/18x\*\*** **I** \*\* min 95 mm \* max 145 mm   130 cm  
min 15 mm max 22 mm
- 6x** **J** min 95 mm max 145 mm   105 cm  
min 15 mm max 22 mm
- 8x\*/12x\*\*** **K** \*\* min 95 mm \* max 145 mm   min 87 / max 91 cm  
min 15 mm max 22 mm
- 12x\*/16x\*\*** **L** \*\* min 95 mm \* max 145 mm   69 cm  
min 15 mm max 22 mm
- 2x** **M** min 95 mm max 145 mm   45° 45° 40 cm  
min 15 mm max 22 mm

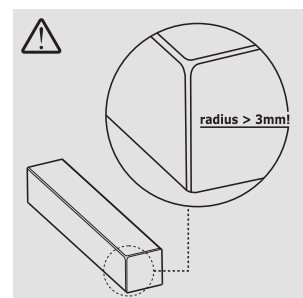
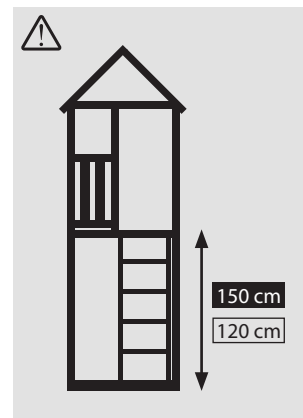

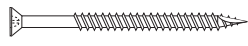
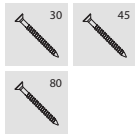

30 mm - 45 mm - 80 mm

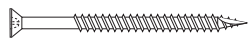
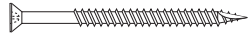

45 mm - 80 mm

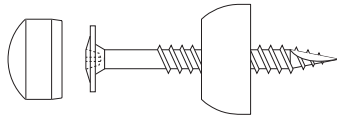

80 mm

4x

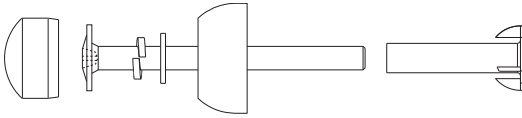

90 / 110 mm

2x

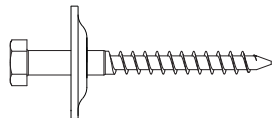

70 mm

4x



2x



1x



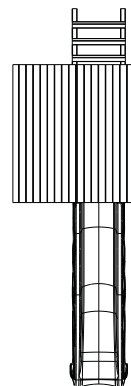
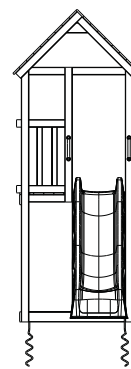
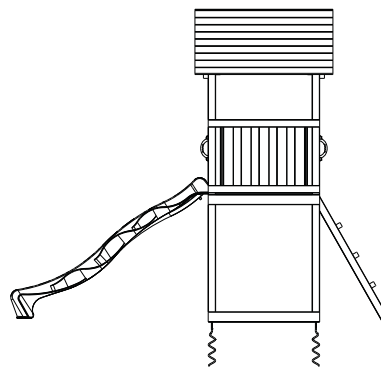
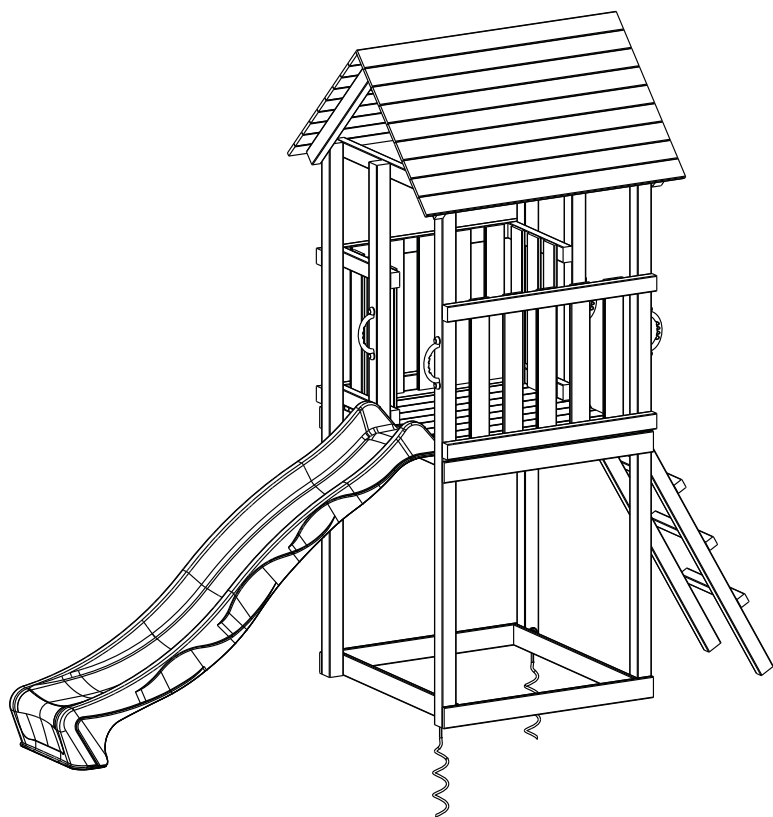

				<p><b>@platform</b> 008.003.006.001</p>	<p><b>@bridge</b> 008.003.004.001</p>		
<p><b>Kiosk</b> 008.001.001.001</p>	<p>150 cm</p>	<p>X</p>	<p>X</p>	<p>(A) (B)</p>	<p>I IV</p>	<p>II III</p>	<p>(A) (B)</p>
	<p>120 cm</p>	<p>X</p>	<p>(A) (B)</p>	<p>X</p>	<p>I IV</p>	<p>II III</p>	<p>(A) (B)</p>

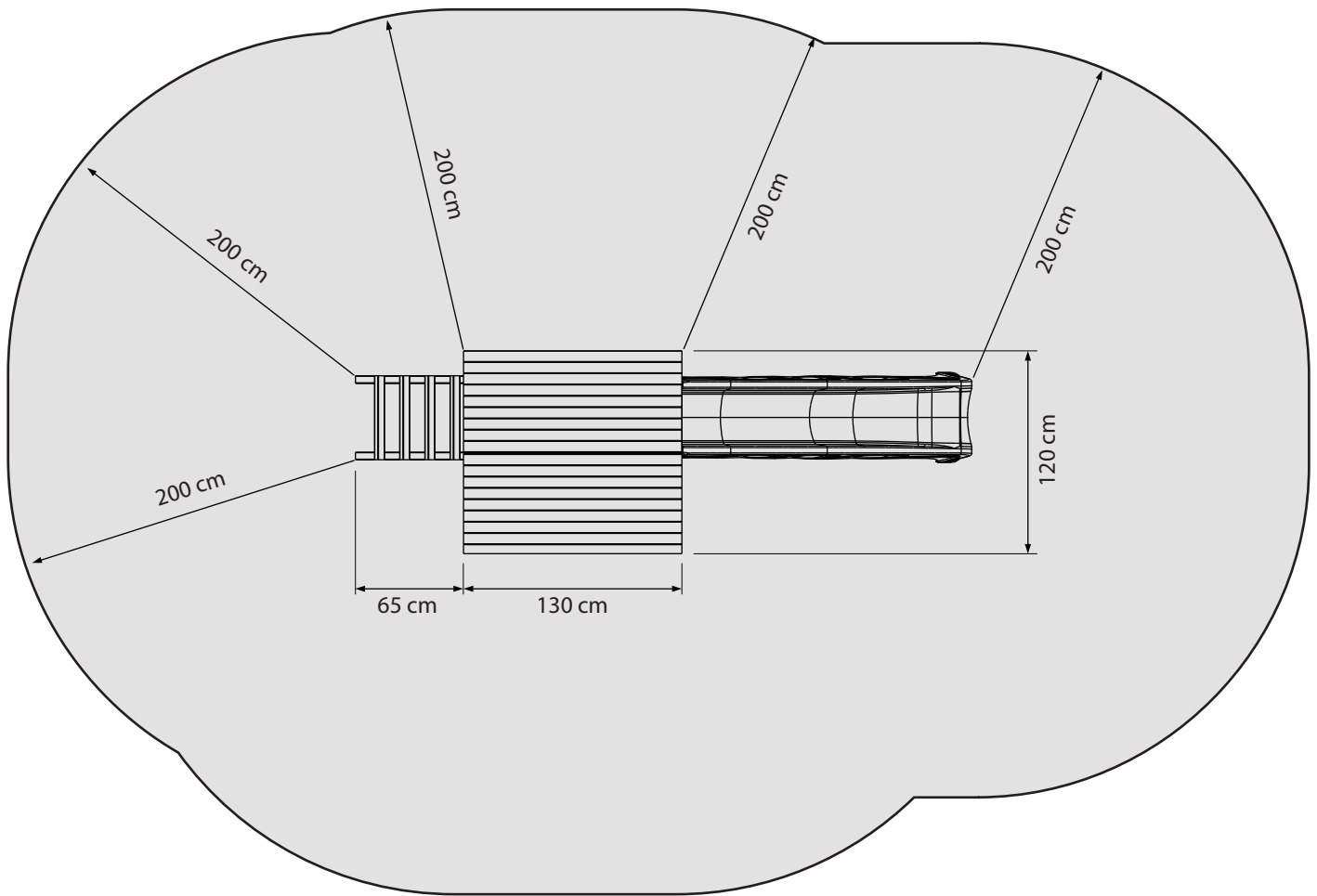

<b>@net</b> 008.003.003.001	<b>@ramp</b> 008.003.002.001	<b>@wall</b> 008.003.001.001	<b>@swing</b> 008.003.005.001	
(A) (B)	(A) (B) <b>X</b>	(A) (B) <b>X</b>	I II III IV <b>X</b>	
(A) (B)	<b>X</b> (A) (B)	<b>X</b> (A) (B)	<b>X</b> I II III IV	

**ERFORDERLICHES WERKZEUG**

- (1) Universalschraubenschlüssel mit Aufsatz 13
- (2) Maßband
- (3) Bleistift
- (4) Bohrer Torx TX20
- (5) Bohrer Torx TX30
- (6) Bohrer Torx TX40
- (7) Bohr- und/oder Schraubmaschine
- (8) Winkelmass
- (9) Holzbohrer, Durchmesser 3 und 5 mm
- (10) Speedbohrer, Durchmesser 10 und 28 mm
- (11) Holzsäge
- (12) Hammer
- (13) Schleifpapier

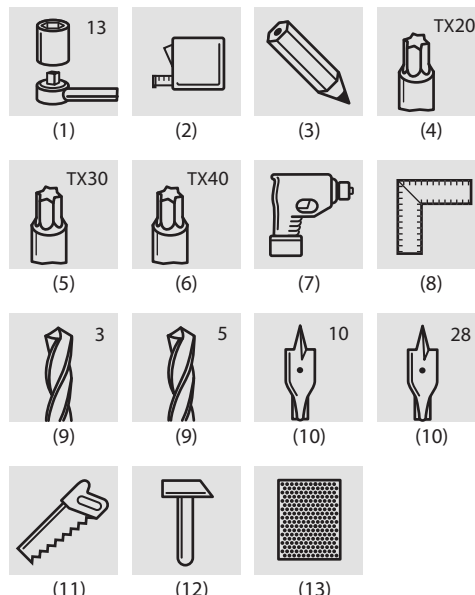

**HOLZSCHRAUBEN**

Schritt 1/ Um zu vermeiden, dass sich das Holz spaltet, empfehlen wir, alle zu schraubenden Holzteile vorzubohren. Bohren Sie immer mindestens 15 mm weniger tief als die Schraube lang ist. Holzschrauben mit einem Durchmesser von 4,5 mm bohren Sie mit einem Holzbohrer von 3 mm vor.  
 Schritt 2/ Drehen Sie die Schraube zuerst einige Millimeter in das zu befestigende Brett, und drücken Sie dies danach kräftig gegen das andere Holz.  
 Schritt 3/ Drehen Sie die Schraube mit dem mitgelieferten Bohrer torx TX20 in das Holz, bis der Kopf der Schraube auf gleicher Höhe mit dem Holz ist.

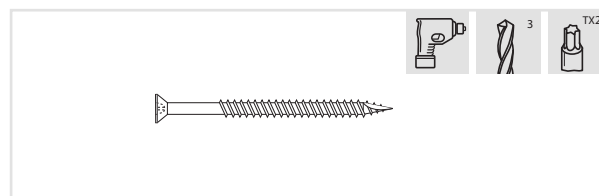

**VIERKANT-HOLZSCHRAUBEN**

Schritt 1/ Um zu vermeiden, dass sich das Holz spaltet, empfehlen wir, alle zu schraubenden Holzteile vorzubohren. Bohren Sie immer mindestens 15 mm weniger tief, als die Schraube lang ist. Vierkant-Holzschrauben mit einem Durchmesser von 8 mm bohren Sie mit einem Holzbohrer von 5 mm vor.  
 Schritt 2/ Bringen Sie die Unterlegscheibe und den untersten Teil der Abdeckkappe über dem Schaft der Schraube an.  
 Schritt 3/ Drehen Sie die Schraube zuerst einige Millimeter in den zu befestigenden Balken, und drücken Sie diesen danach kräftig gegen das andere Holz.  
 Schritt 4/ Ziehen Sie die Schraube mit der mitgelieferten Bohrer torx TX40 an.  
 Schritt 5/ Drücken Sie die Kappe der Abdeckkappe in die vorgesehene Öffnung.

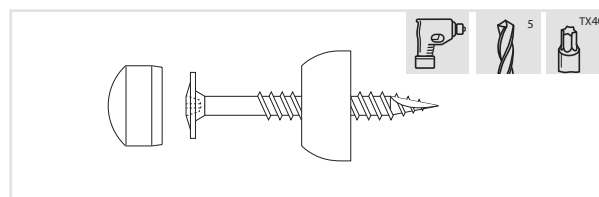

**SCHRAUBVERBINDUNGEN**

Schritt 1/ Bohren Sie ein Loch mit einem Durchmesser von 10 mm durch beide bereits aneinander geschraubte Bretter oder Balken (siehe 'Holzschrauben').  
 Schritt 2/ Schlagen Sie die Druckmutter mit einem Hammer entlang der angegebenen Seite des Balkens in das Loch.  
 Schritt 3/ Bringen Sie den Federring, die Unterlegscheibe und danach den untersten Teil der Abdeckkappe über dem Schaft der Schraube an.  
 Schritt 4/ Schieben Sie die Schraube durch das Loch, und drehen Sie mit der Hand einige Umdrehungen, bis sich die Schraube zügig in die Druckmutter reht.  
 Schritt 5/ Ziehen Sie die Schraube mit der mitgelieferten Bohrer torx TX40 an, bis der Federring zwischen dem Kopf der Schraube und der Unterlegscheibe vollständig flachgedrückt ist.  
 Schritt 6/ Drücken Sie die Kappe der Abdeckkappe in die vorgesehene Öffnung.

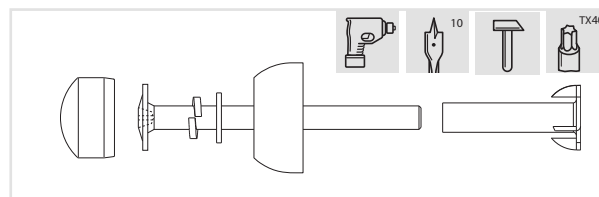



1

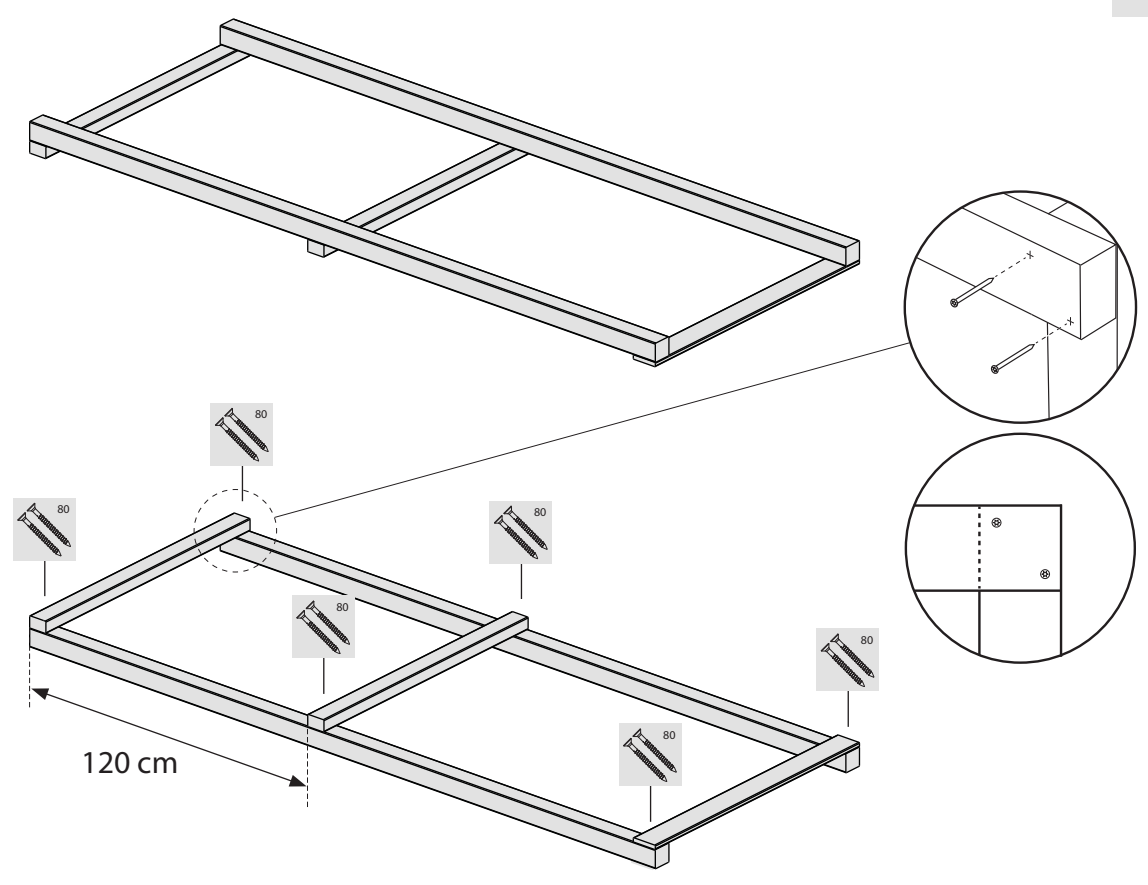

-  **4x**
-  **4x**
-  **2x**
-  **12x**



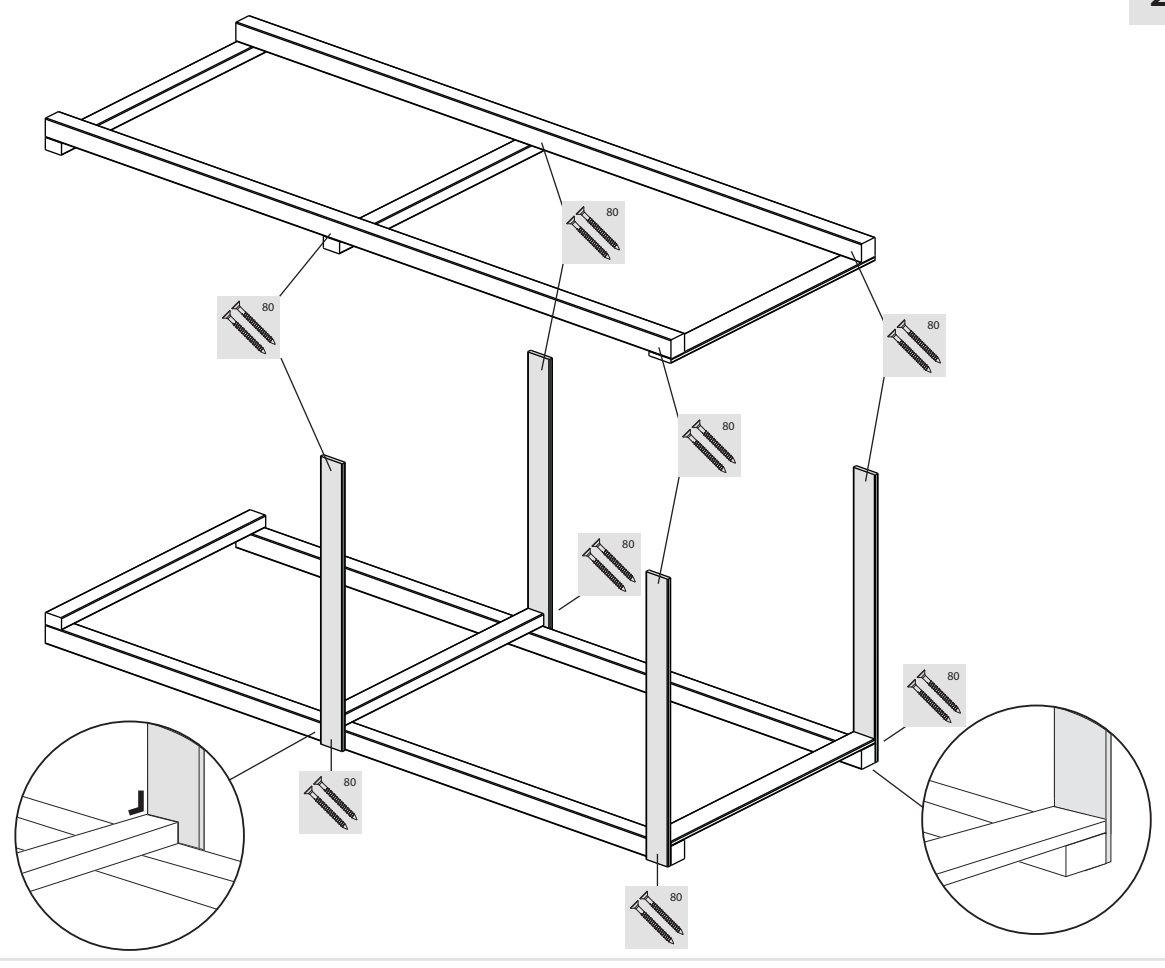

2

-  **4x**
-  **8x**

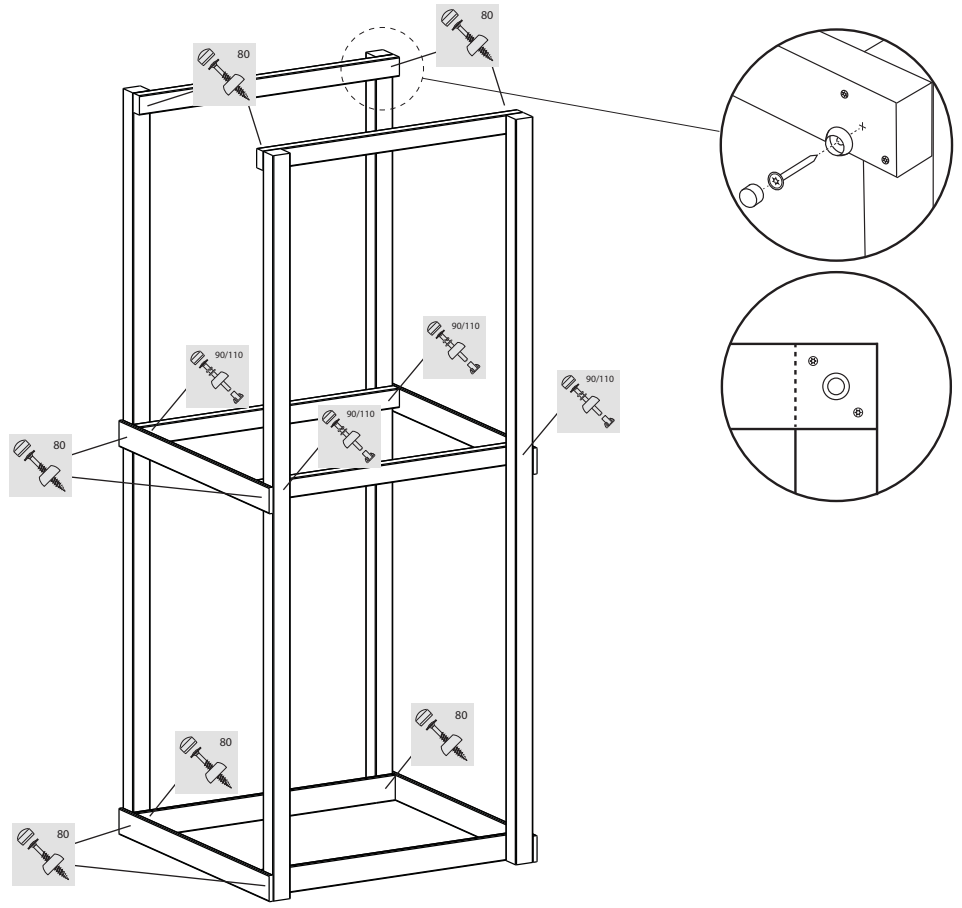

-  16x
-  4x



-  1x
-  2x

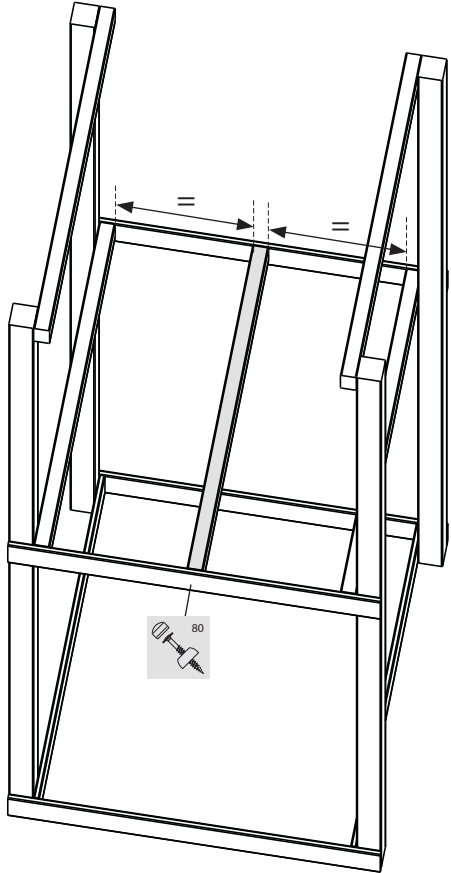



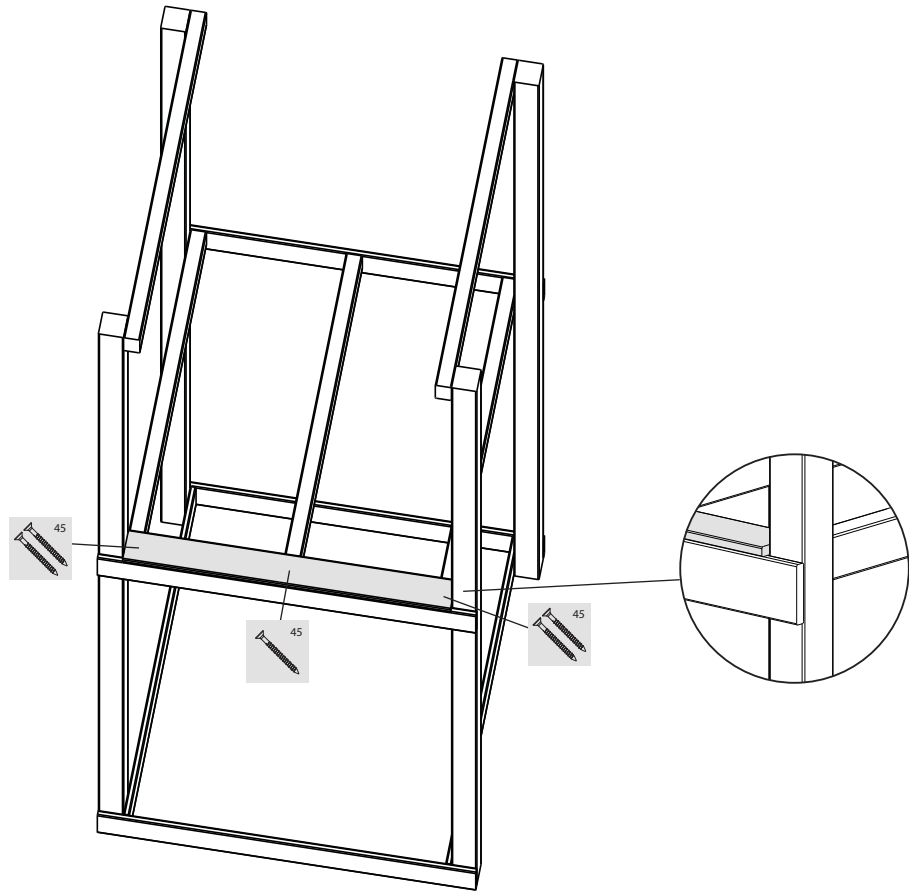

5a

-  1x
-  45 2x
-  45 1x





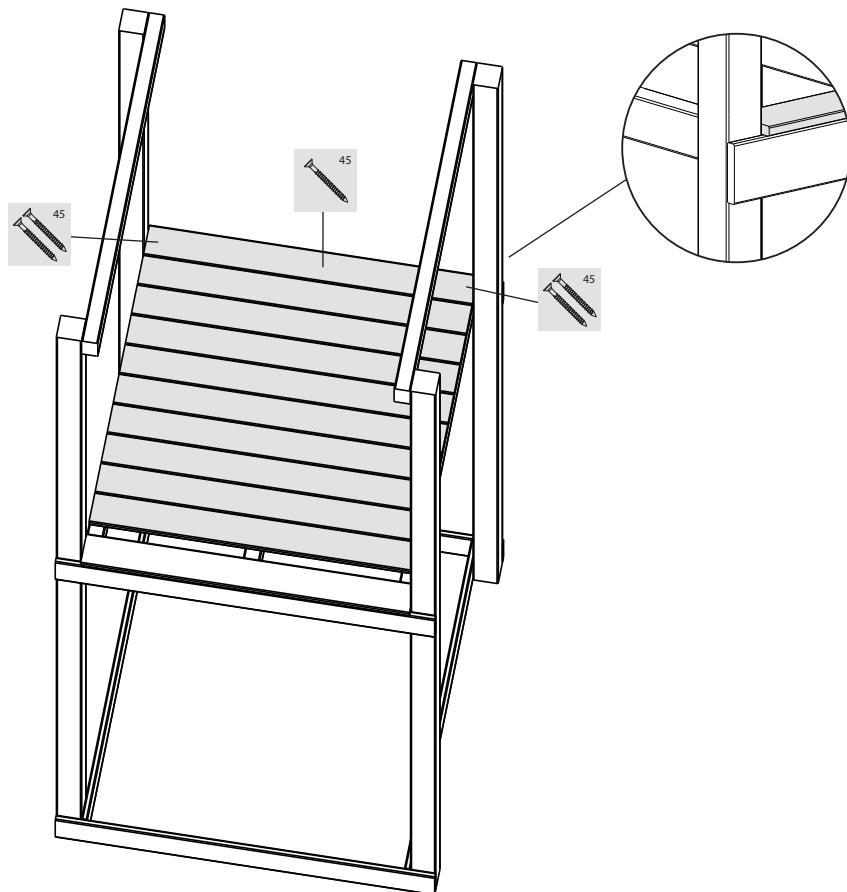

5b

-  6x/10x
-  45 20x
-  45 10x

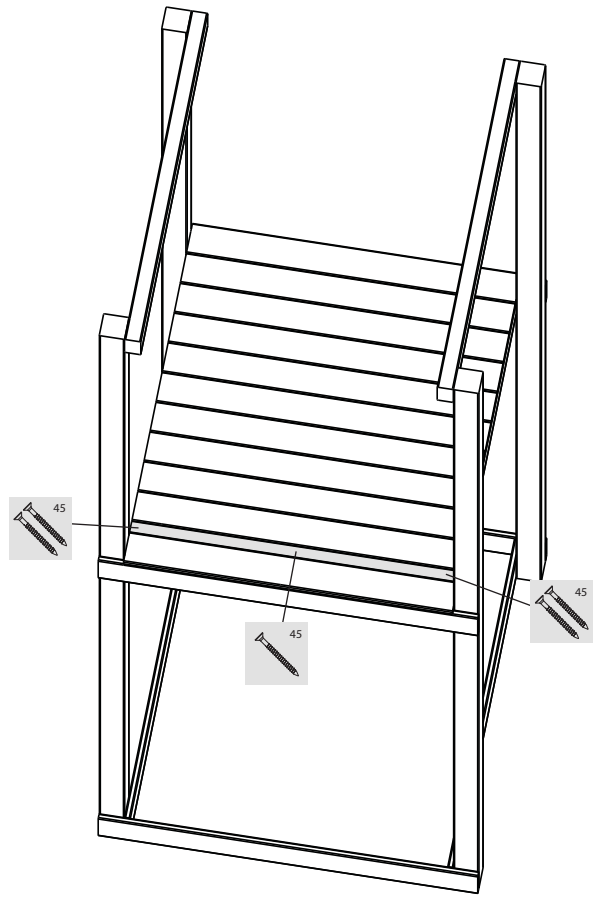
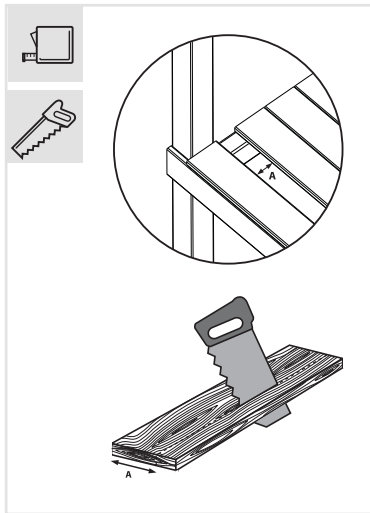

-  **1x**
-  **2x**
-  **1x**



-  **2x**
-  **3x** **4x**
-  **8x**

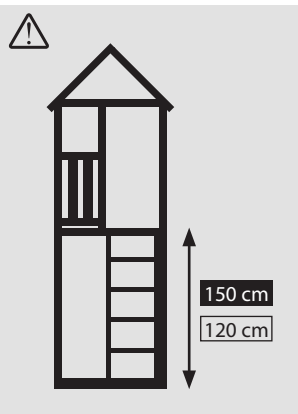
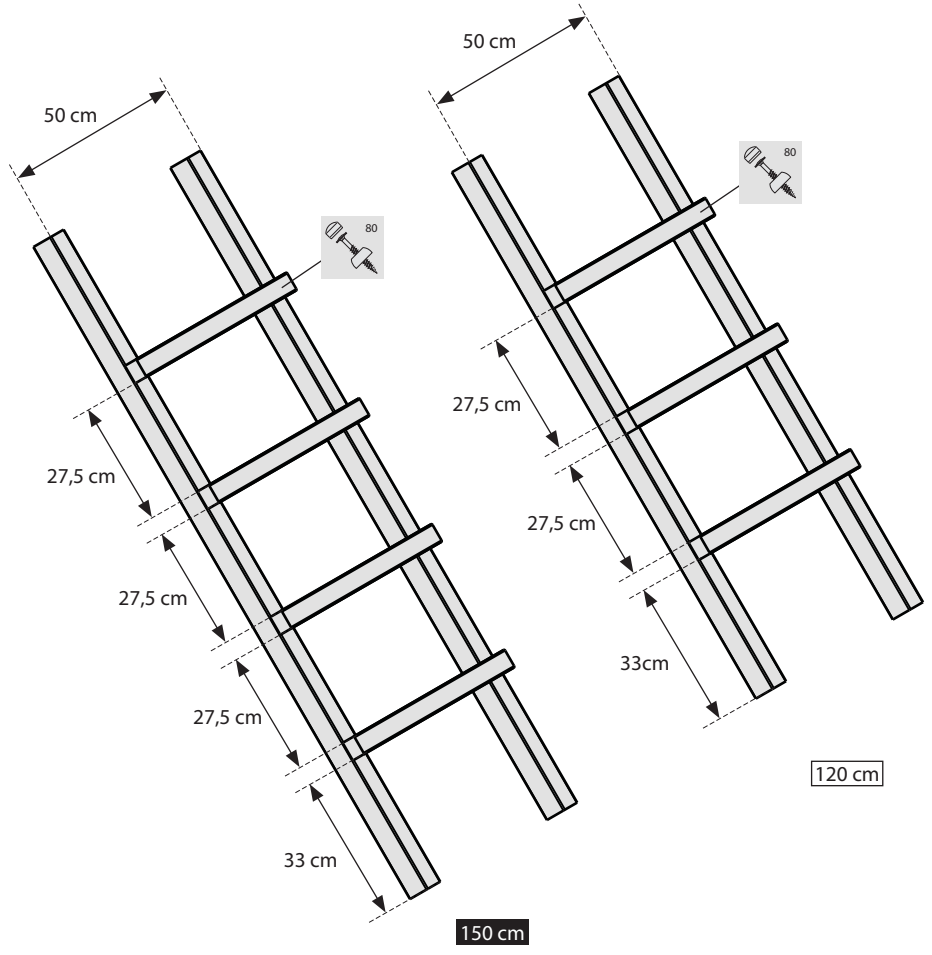

 80 **1x**

**6b**

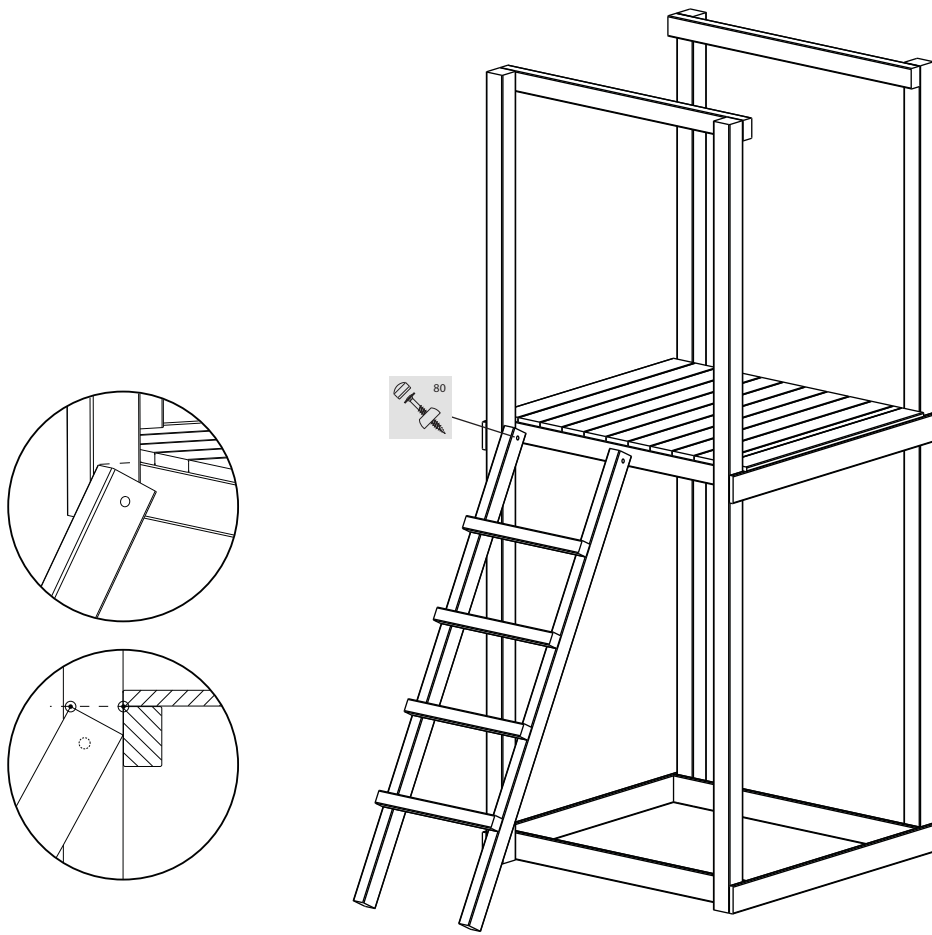

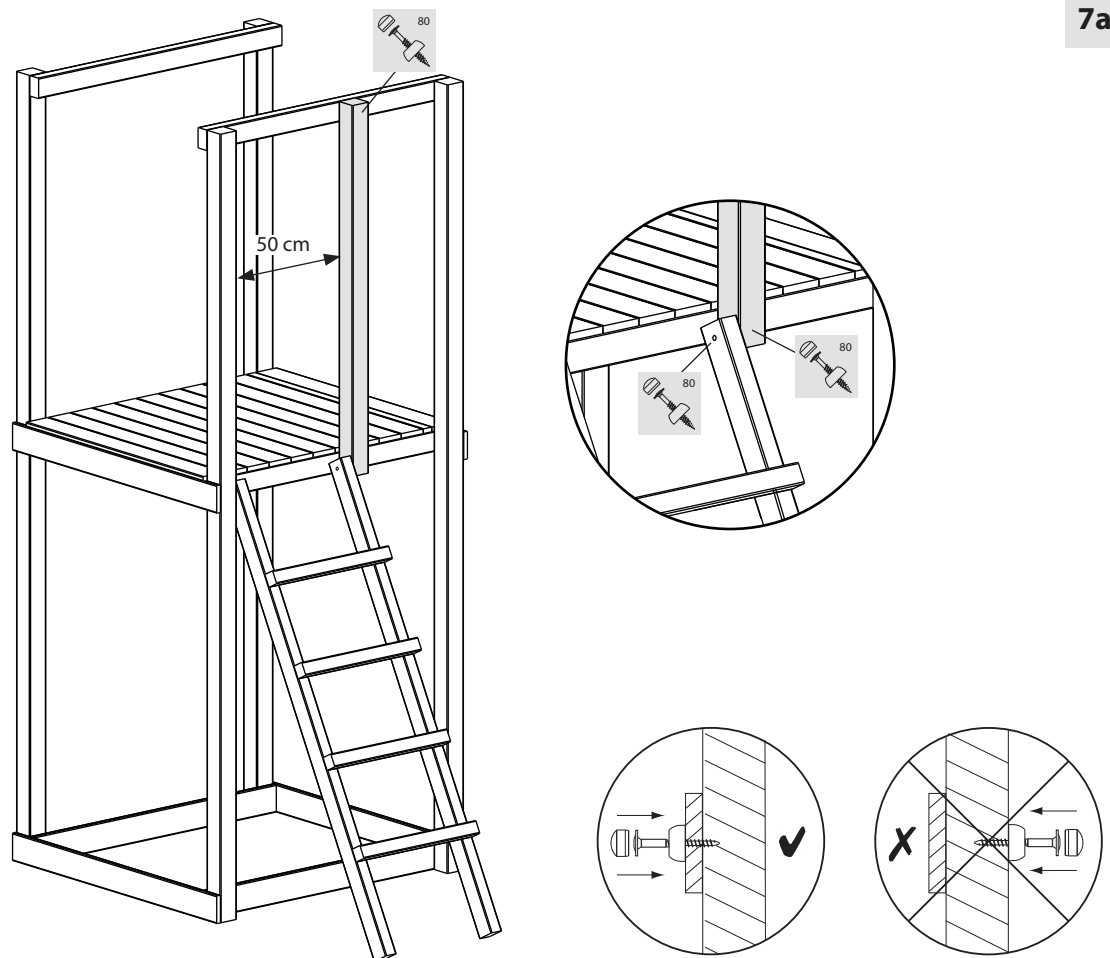

 **1x**  
 80 **3x**

**7a**



7b

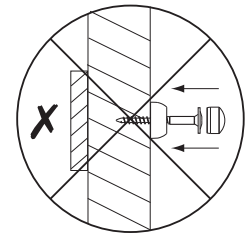
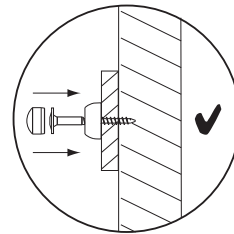
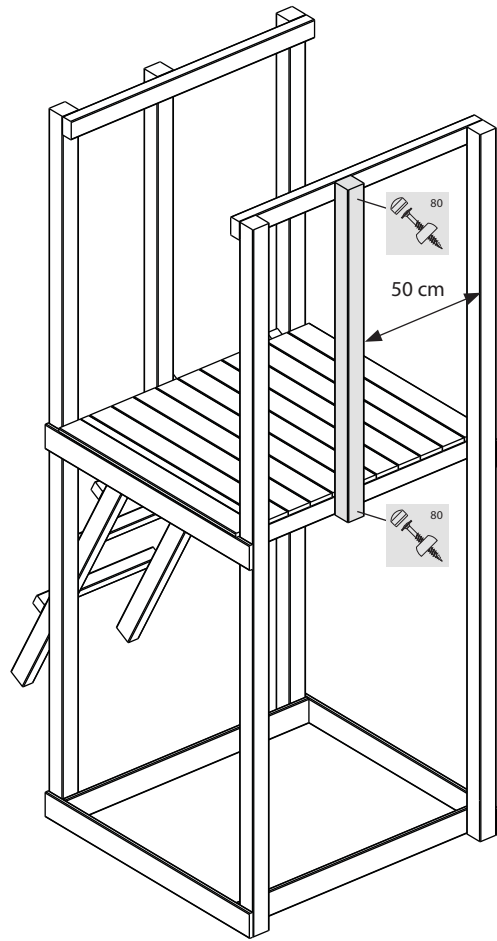

-  1x
-  2x



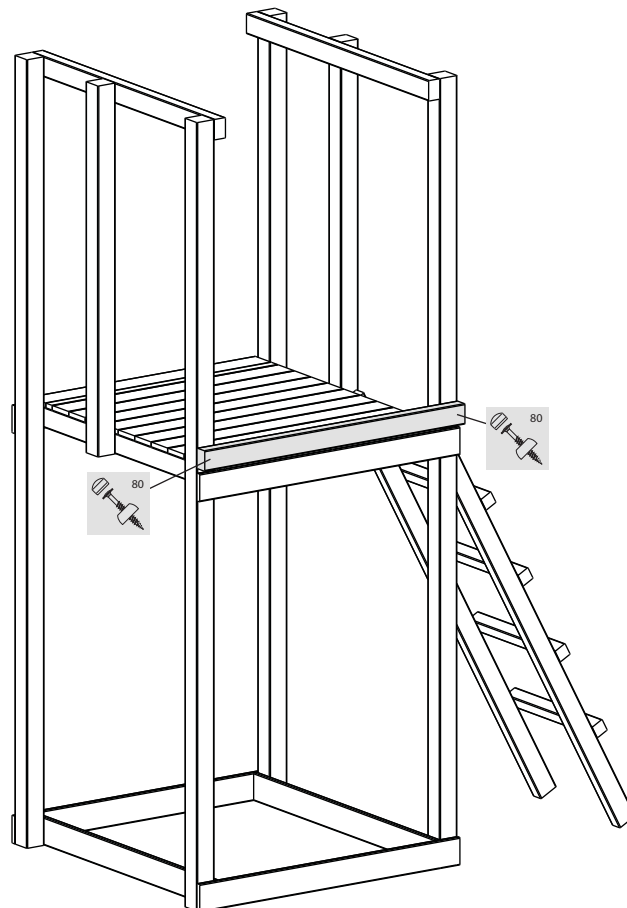

8a

-  1x
-  2x



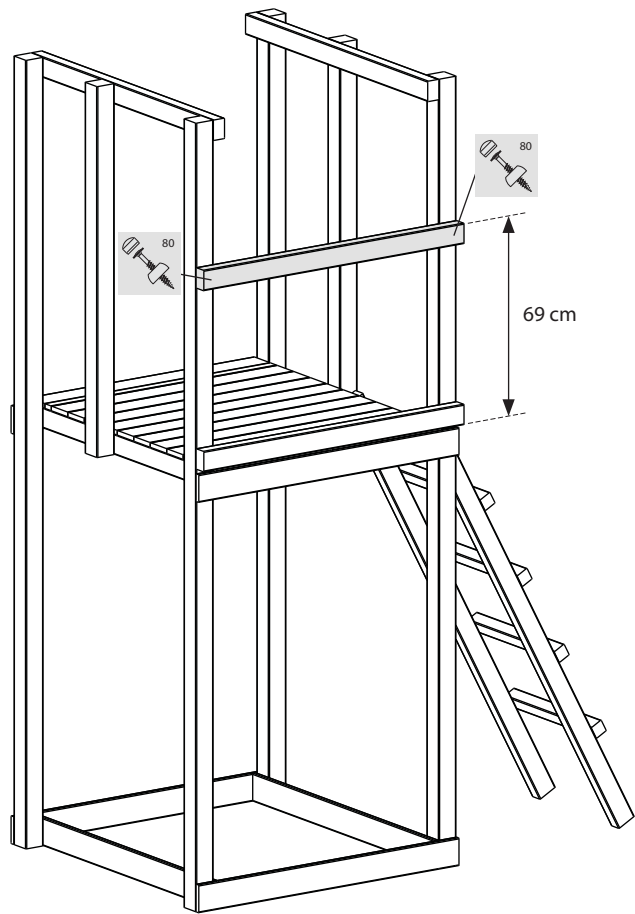

-  1x
-  2x

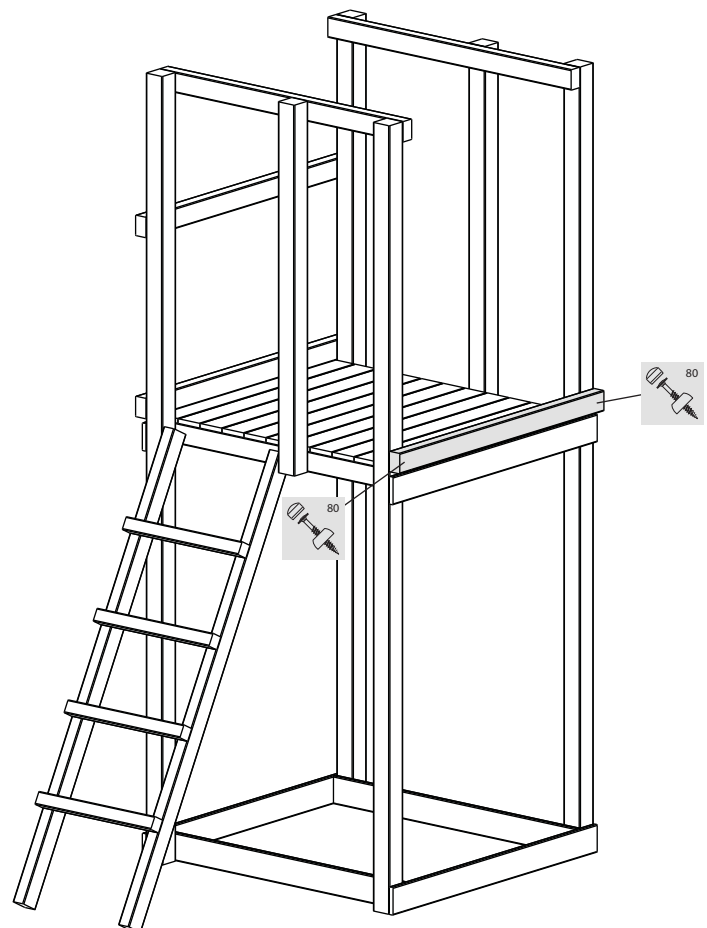

-  1x
-  2x



8d

-  1x
-  2x

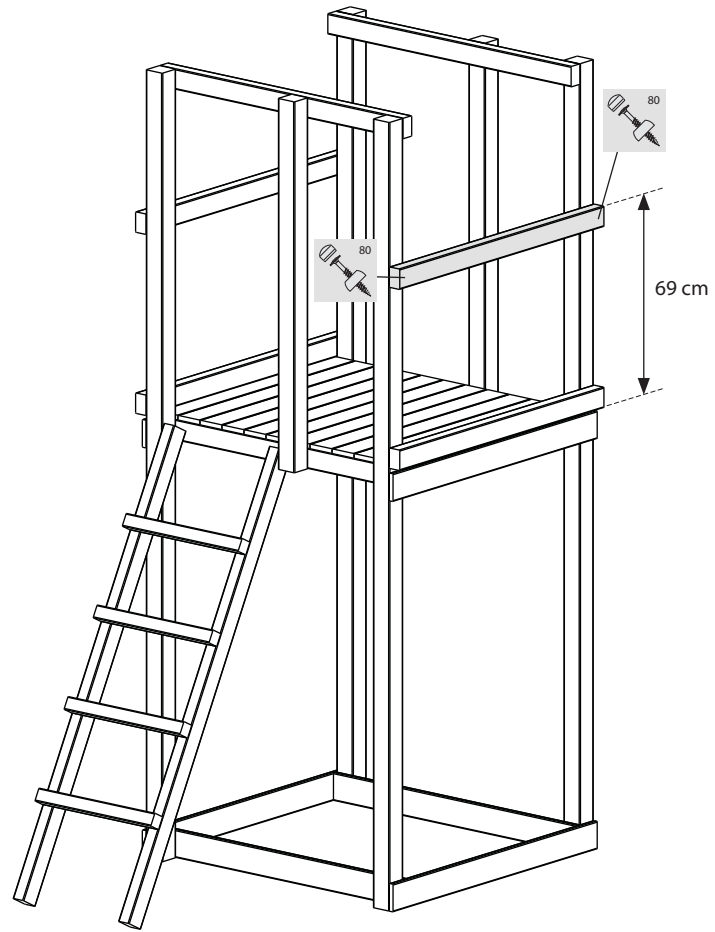

8e

-  1x
-  2x

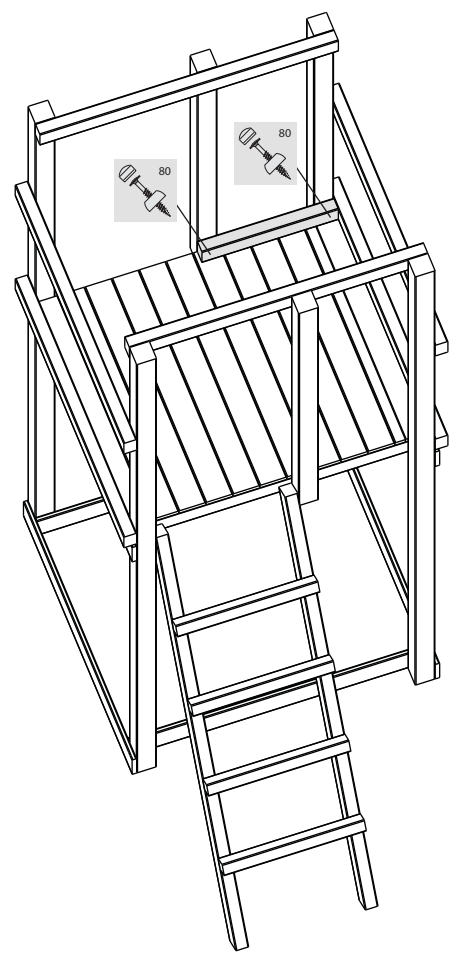

-  1x
-  2x

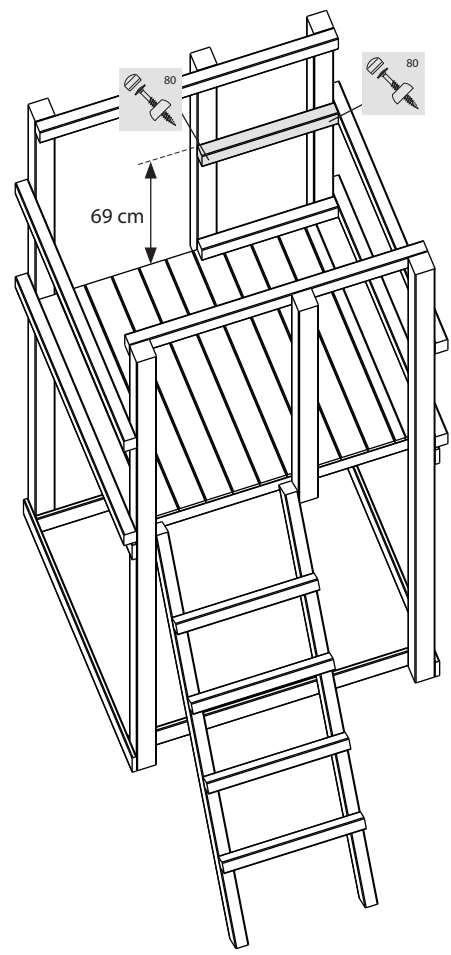

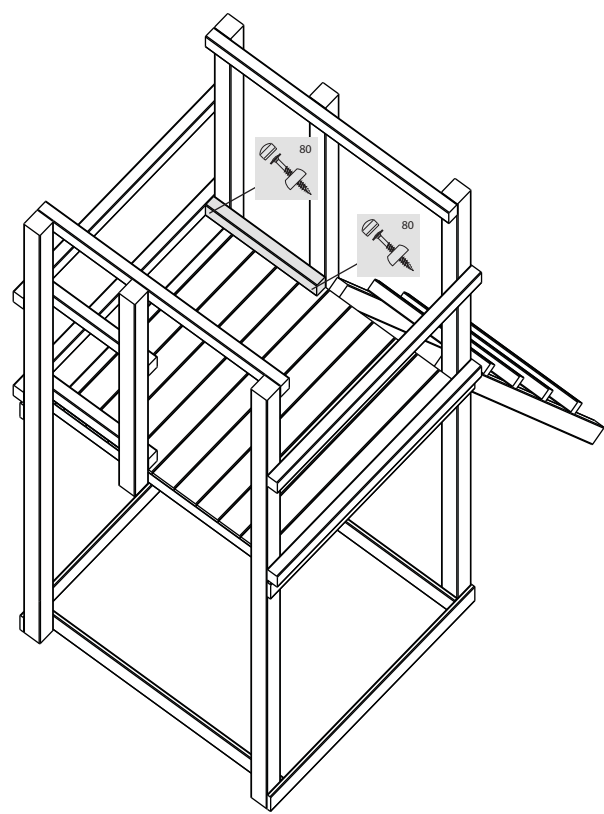

-  1x
-  2x

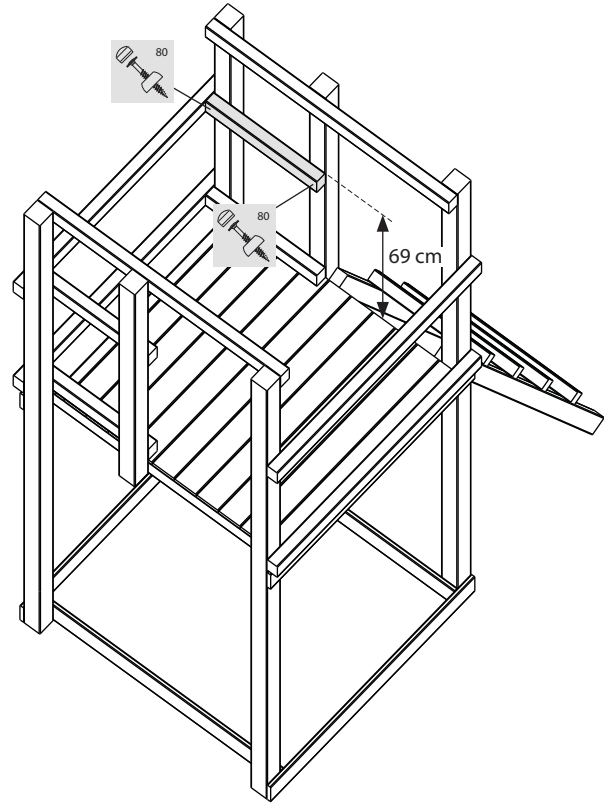

-  1x
-  2x



-  4x/5x
-  10x

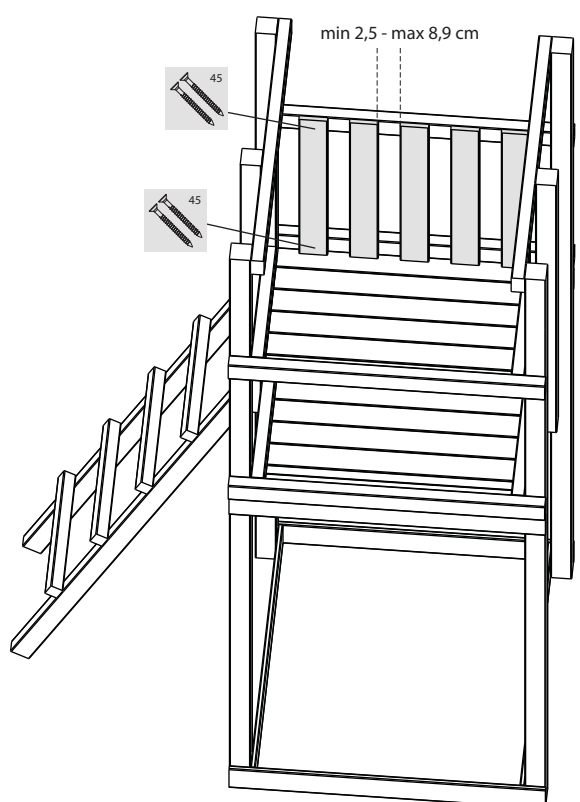



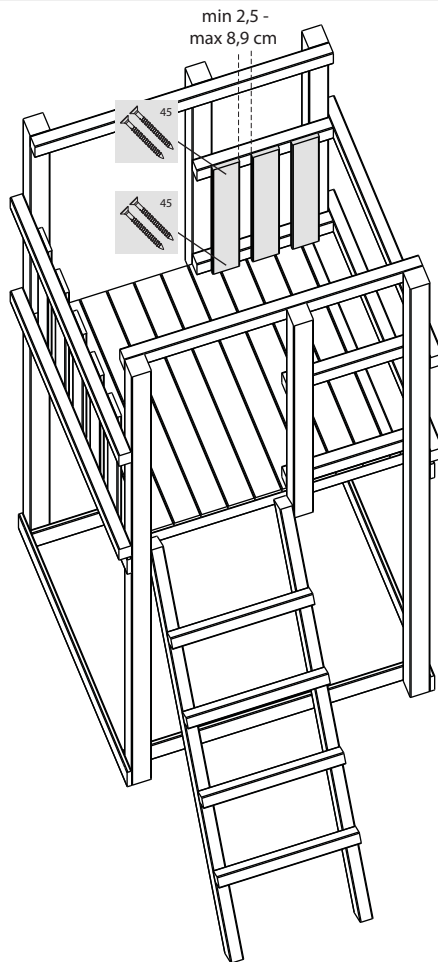

**G** 2x/3x  
45  
**6x**

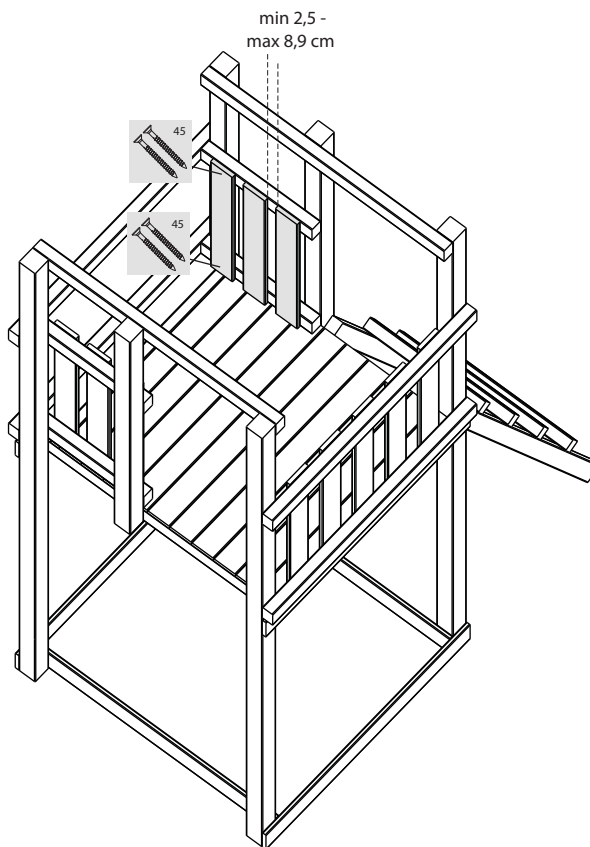

**G** 2x/3x  
45  
**6x**



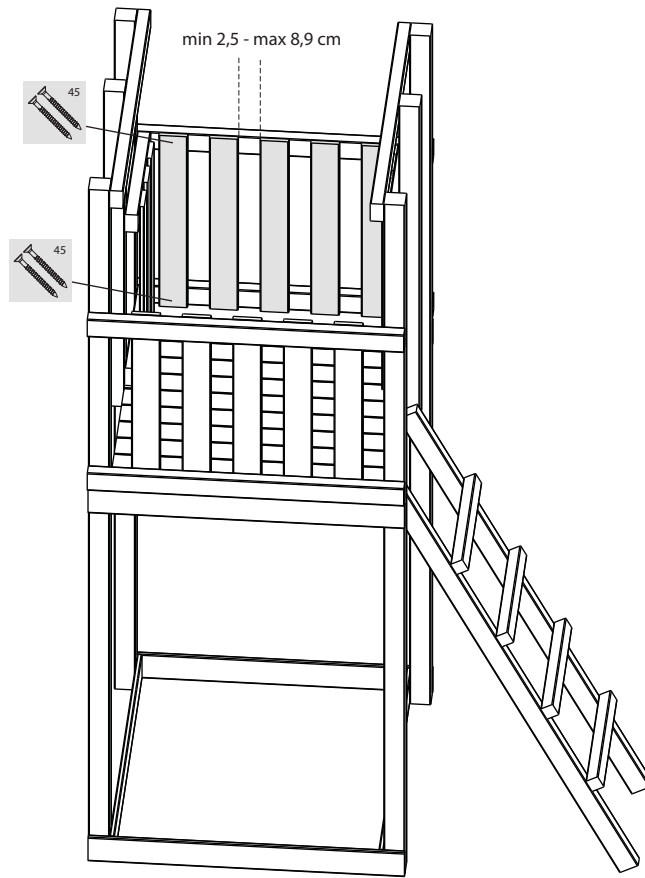

-  **4x/5x**
-  **10x**

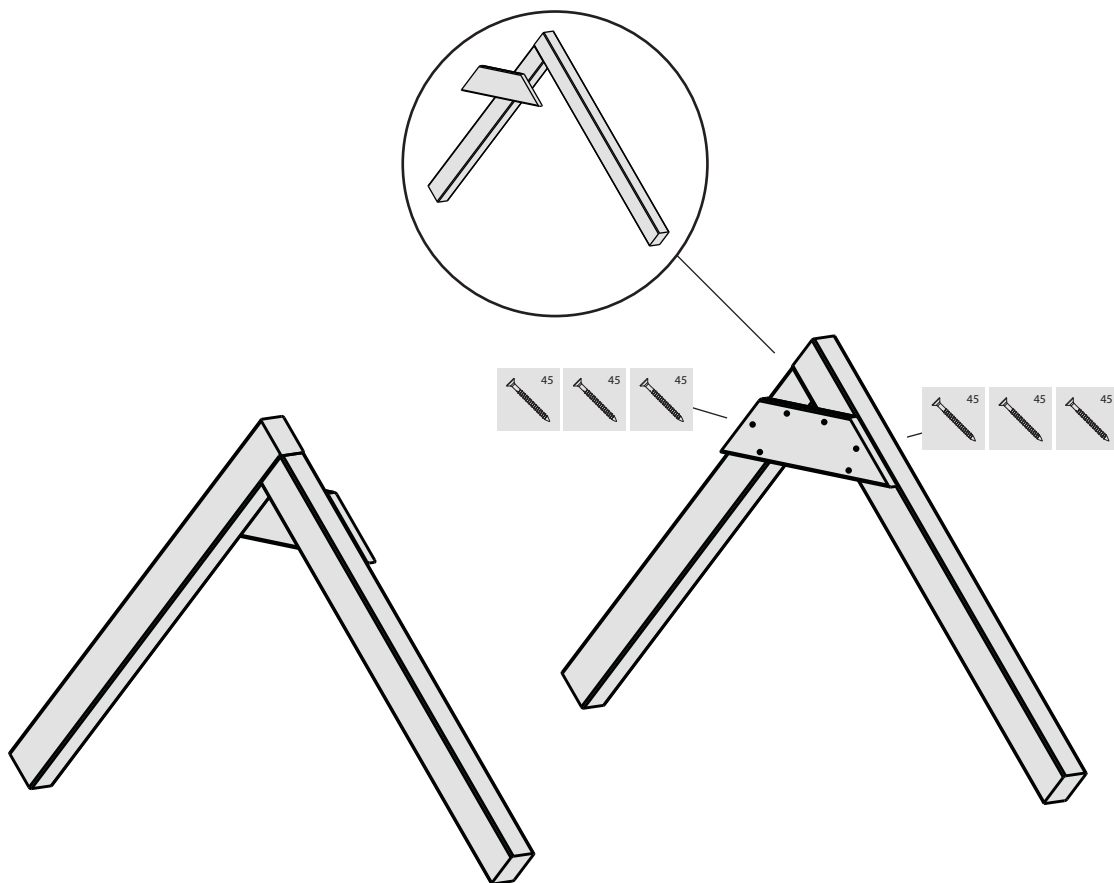

-  **2x**
-  **2x**
-  **2x**
-  **12x**



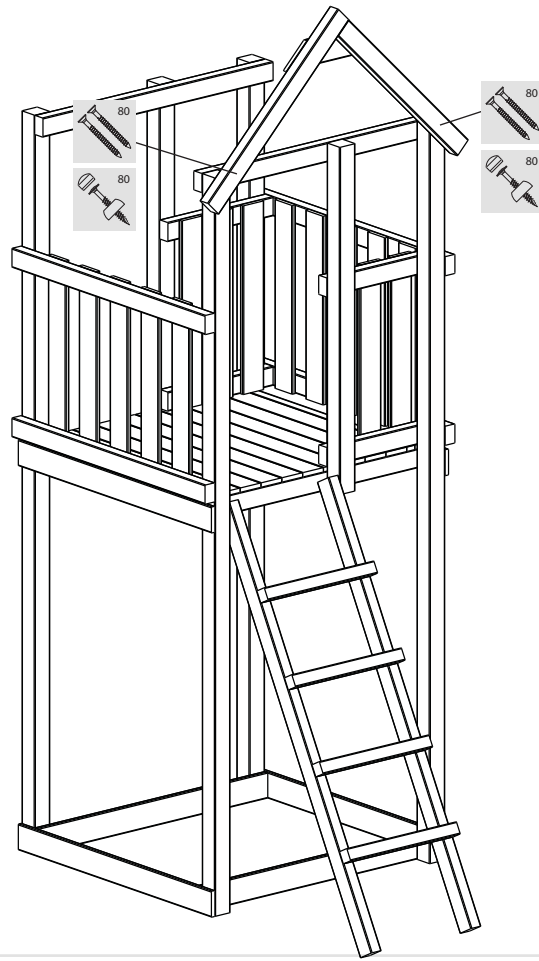

-  80 **2x**
-  80 **2x**

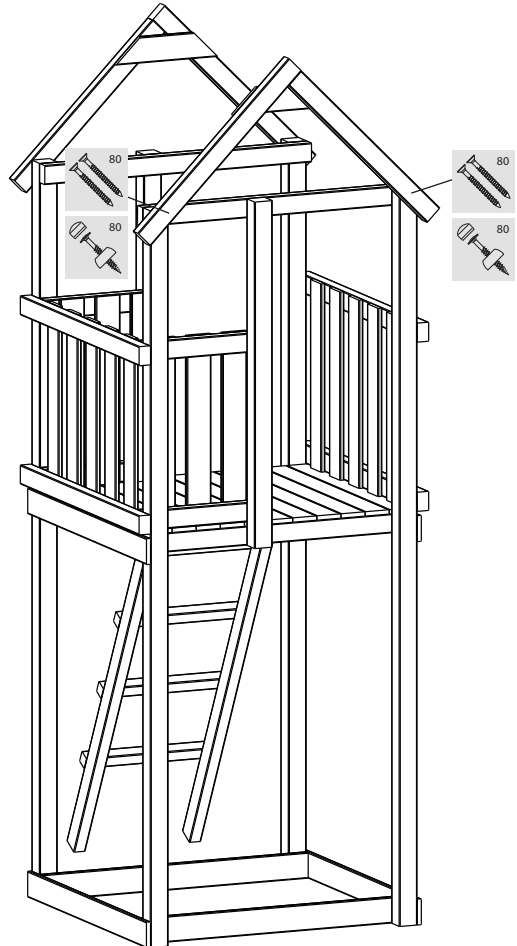

-  80 **2x**
-  80 **2x**





13d

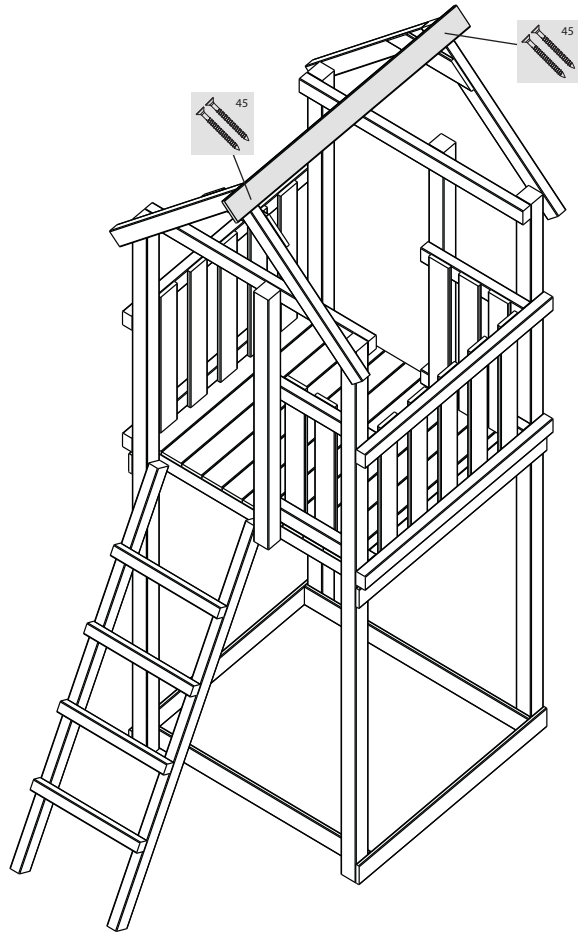

-  1x
-  2x



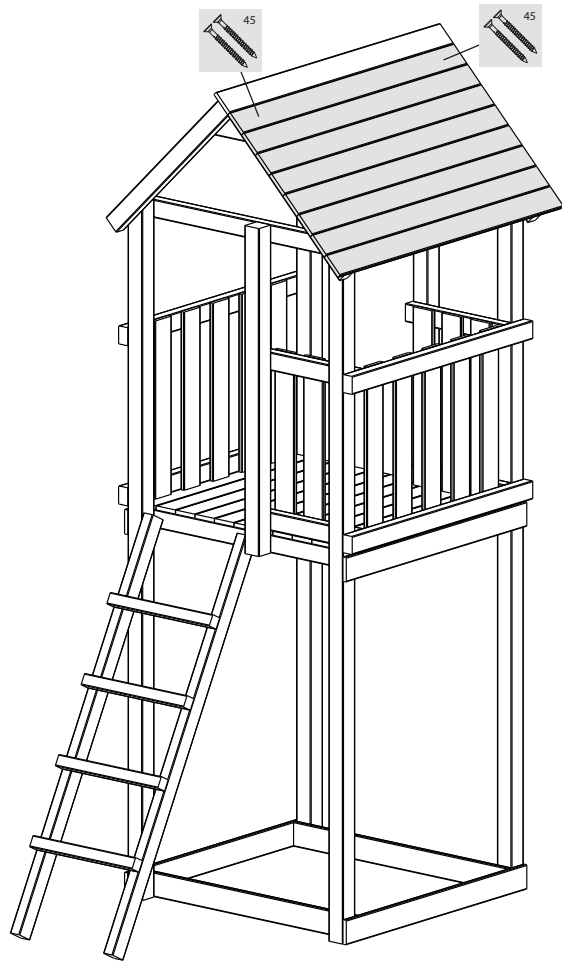

13e

-  5x/8x
-  16x

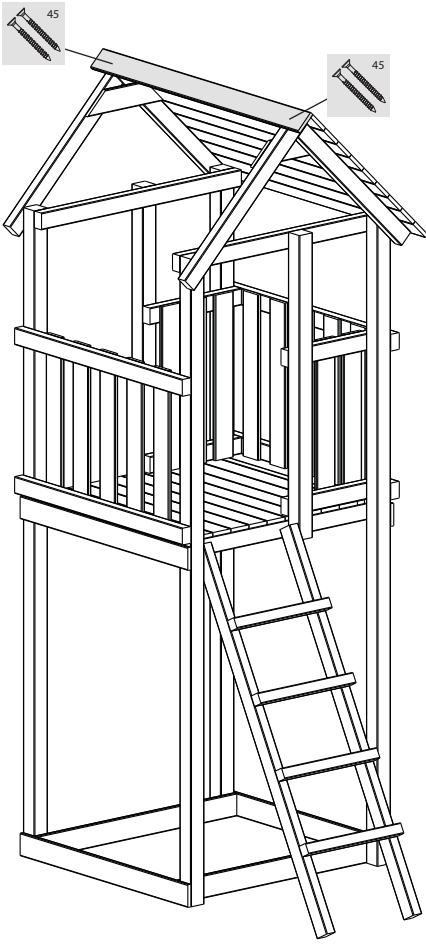

-  1x
-  2x



-  5x/8x
-  16x

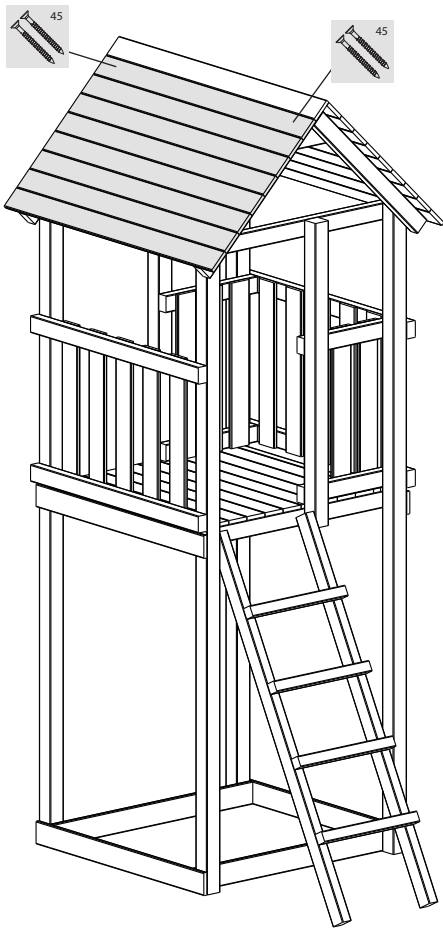



4x

14

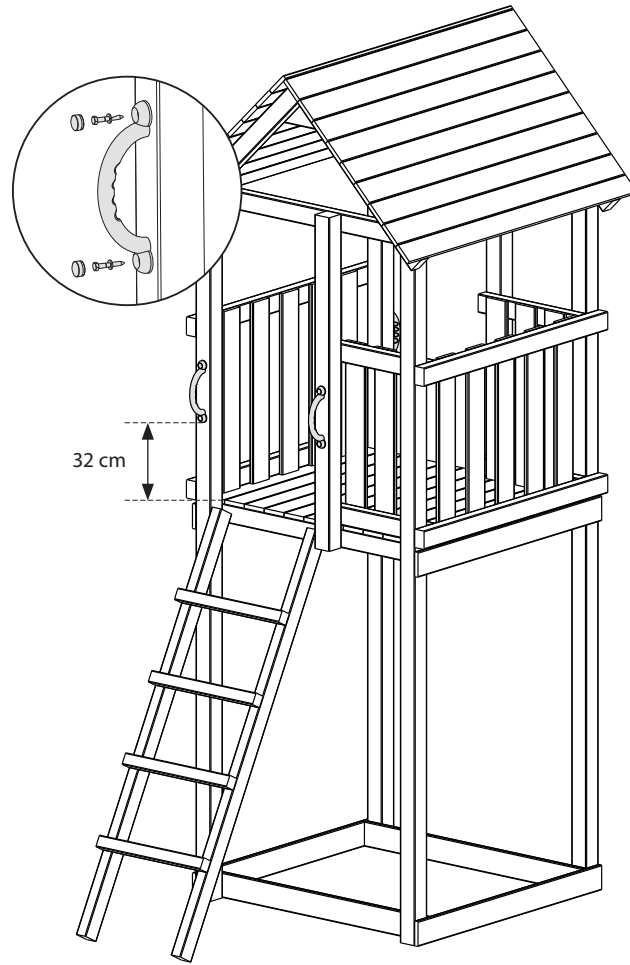



2x

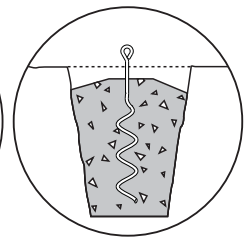
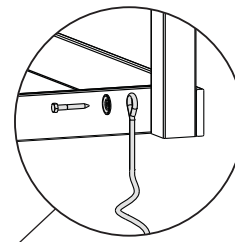
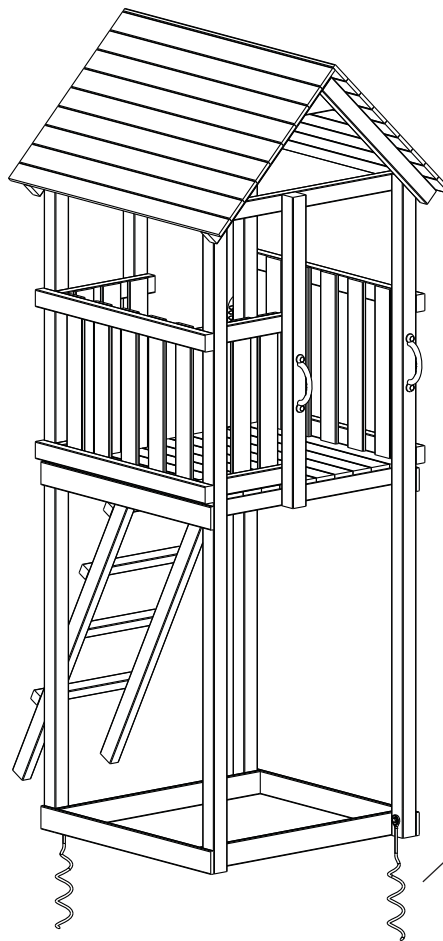

2x

15



-  1x
-  2x

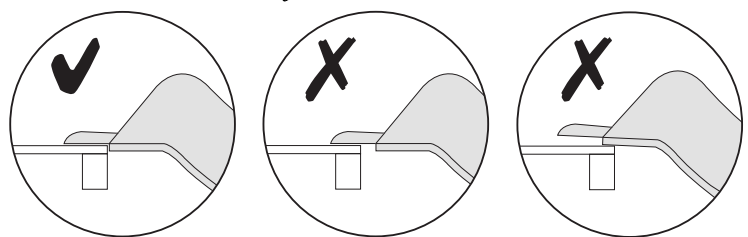
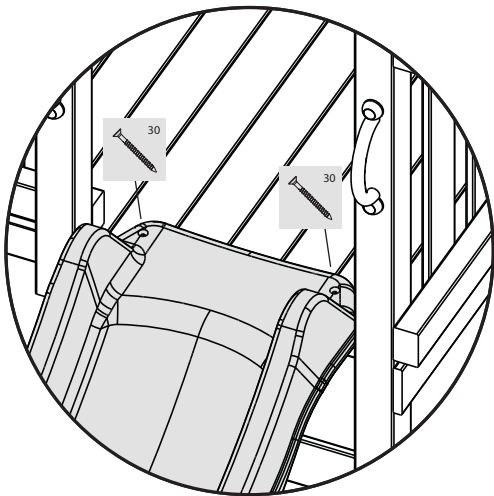
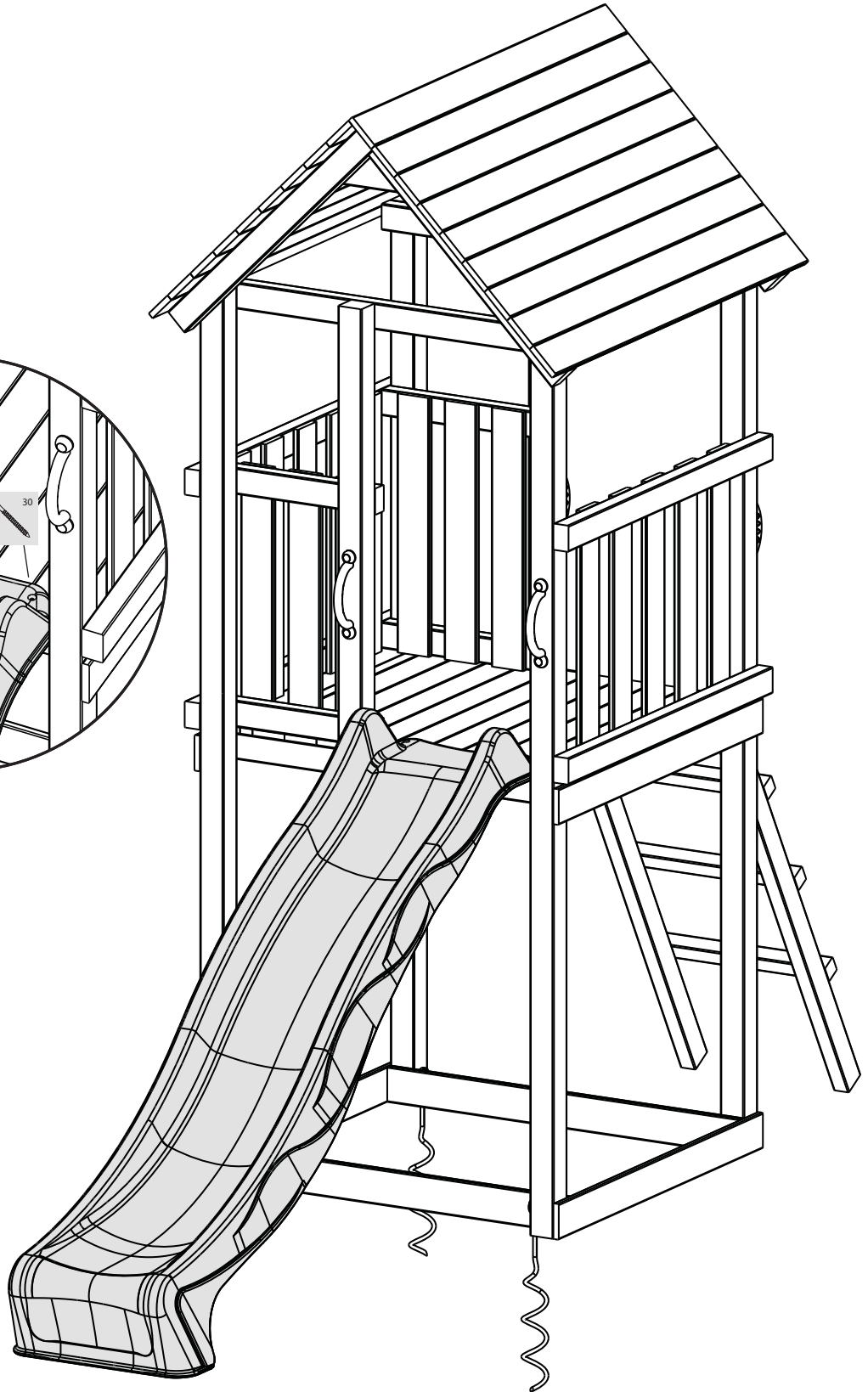



**blue rabbit**

---

Blue Rabbit 2.0®  
Hemelrijken 8  
B-2890 Sint-Amands  
BELGIUM

[www.bluerabbit.be](http://www.bluerabbit.be)